

Opening: 31 Sq Ft Maximum
Area: 250 Sq Ft Maximum

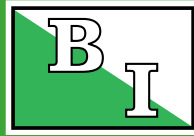

MODEL RDP-16

REMOTE MOUNT DUAL BLOWER BUILDING PRESSURIZATION UNIT

ECU Division Technical Bulletin RDP-16-R1.0

05/97



RDP Horizontal Side
Angle View



Control Enclosure

Technical Description

Model RDP-16 is a remote-mount pressurization unit for control rooms or buildings containing no internal source of flammable vapors or gases. The unit utilizes a primary and secondary fan to pressurize rooms or buildings with opening(s) not exceeding a total of 31 square feet and a floor area not exceeding 250 square feet. The primary fan is controlled by a variable speed drive to maintain a safe (0.25") pressure when the doorway is sealed. The secondary fan engages upon loss of safe pressure, to generate a minimum air velocity of sixty (60) feet per minute through the doorway, and functions as a redundant fan if the primary fan fails. This unit, combined with an intake system that draws fresh air from a nonhazardous area, reduces the hazardous (classified) area rating within the room or building from Class I, Division 1 or 2 to nonhazardous, in accordance with NFPA 496, Chapter 5.

Basic Operation

Unit must be powered by a local disconnect switch connected ahead of building power or connected to a separate power source. The unit is started by closing the building door and placing the secondary fan switch in the "automatic" position and the primary fan switch in the "on" position. The primary fan then engages to regulate air flow and maintain a safe pressure. When the door is opened, pressure will fall below the alarm setpoint. The primary fan will then increase velocity, and the unit will activate an alarm signal delay timer and a secondary fan delay timer. These timers are field-adjustable to permit immediate or delayed response to changes in pressure. Both timers are activated and reset as pressure falls below and rises above the alarm setpoint. If the secondary fan or alarm engages, they disengage when the door is sealed and pressure rises above the alarm setpoint.

DIVISION 1 AREA APPLICATION NOTE:
INSTALLER MUST PROVIDE DISCONNECT EQUIPMENT TO AUTOMATICALLY REMOVE POWER FROM ALL NONRATED DEVICES, UPON FAILURE OF THE PRESSURIZATION UNIT.

Standard Controls

Primary Fan "On" Indicator

- indicates that primary fan is engaged
- flashes when the ESD or ECO is engaged

Primary Fan Control Switch

- engages and disengages primary fan

Secondary Fan Control Switch

- off, manual and automatic positions

Alarm "Engaged" Indicator

- indicates alarm signal is active
- flashes when alarm signal is bypassed

Alarm Signal Bypass Switch

- allows bypass of alarm relay

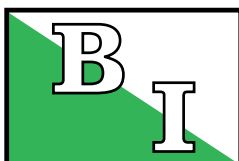

Bebeco Industries
Environmental Control Units Division

600 Gulf Freeway
Texas City, TX 77591
PHN: (409) 935-5743
FAX: (409) 938-4189

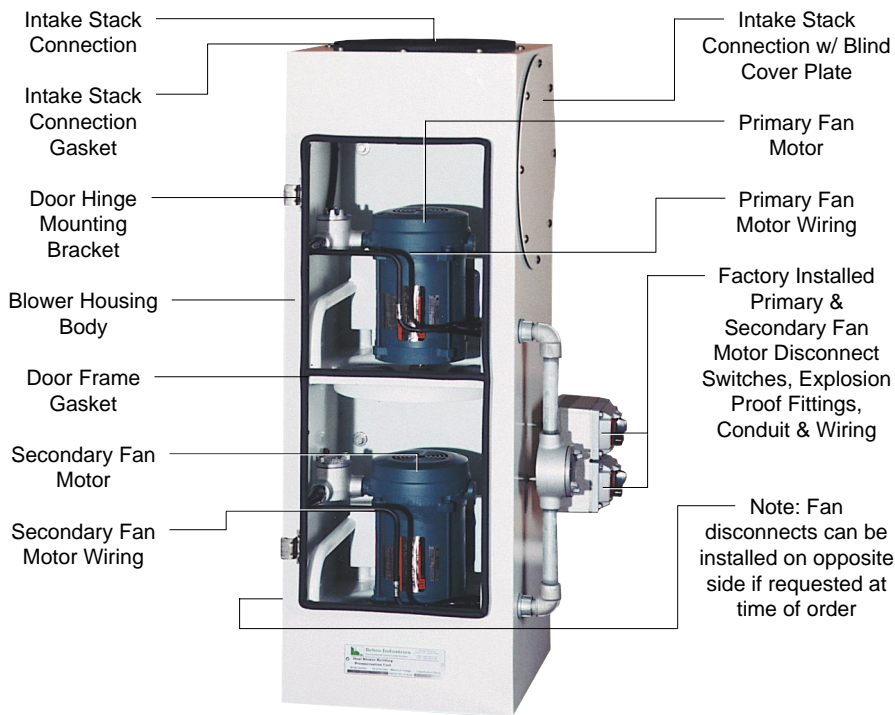

Blower Housing
top view with door removed

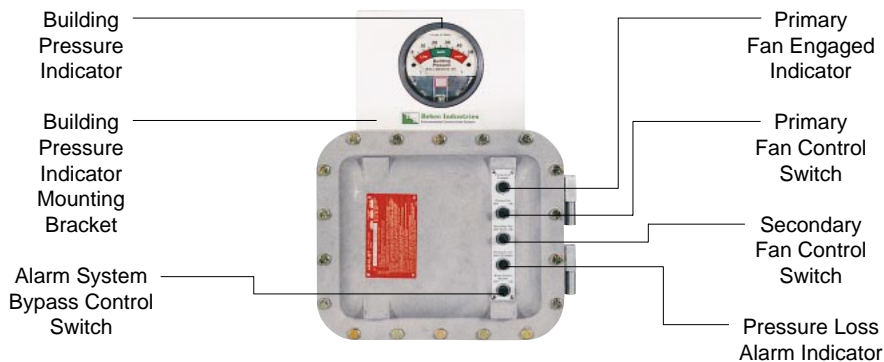

Control Enclosure
face view with door closed

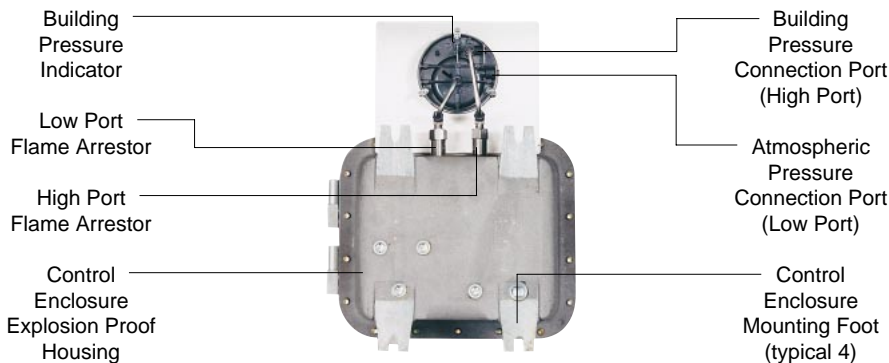

Control Enclosure
rear view

Unit Specifications

Shipping Dimensions:	32" h x 32" w x 72" d
Shipping Weight (Lbs):	402
Operating Temp Range:	-40° F - 120° F
Power Requirements:	208 / 240 VAC 1Ø, 20 A
Safe Pressure Setpoint:	0.25" - field adjustable
Alarm Setpoint:	0.15" - field adjustable
Average CFM:	* 79.03
Maximum CFM:	2450
Normal Sound Level:	** 60 db min. / 70 db max.
Fresh Air Intake:	16" Diameter
Field Wiring Conduit Entries:	3/4" FPT
Alarm Contact Rating:	15 Amps @ 120 VAC
Division 1 Unit Motors:	Rated Cl. I, Div. 1, Gr. C & D
Division 2 Unit Motors:	Rated Cl. I, Div. 2, Gr. C & D
Primary Motor:	3Ø Inverter Duty, T3, 80 Hz
Secondary Motor:	1Ø Perm. Split Cap., T3, 60 Hz
Primary Motor RPM:	2000 Max.
Secondary Motor RPM:	1725 Max.

* Average CFM through a 31 square feet opening

** Normal sound level tested in acoustic sound chamber with primary fan engaged and door sealed

Material Specifications

NEMA 4 Blower Housing:	* Painted 14 Ga Galv. Steel
NEMA 4X Blower Housing:	*Painted 14 Ga 316 SS
Fan Venturis:	Painted Carbon Steel
Fan Blades:	Nonsparking Alum.
Pressure Gauge:	Alum. w / Enamel Finish
Tube Fittings:	316 SS & Nylon
Unit & Device Nameplates:	Silkscreened Lexan®
Model Number Nameplate:	Silkscreened SS
Cover Plate Fasteners:	SS Screws & Bolts
Access Door Fasteners:	Cast Zinc Body / Zinc Bolt
Elect. Enclosures & Fittings:	Cast Zinc & Aluminum
Electrical Wiring:	Brass MI Cable & Fittings w/ PVC Jacket

* Paint Finish Specifications:

2 mil epoxy primer & 2 mil white textured urethane finish

Lexan® is a registered trademark of the General Electric Corporation

Mechanical Description

The body of Model RDP-16 is a seal-welded NEMA 4 or 4X blower housing that features one (1) full size access door, three (3) intake openings, and two (2) opening covers. The housing is designed for remote mounting in combination with Bebcos Models ADGA, DCF, DE and/or DN ductwork for installation on the wall or roof of the protected building. In addition, the housing can be supplied with an optional emergency remote control junction box for ECO or ESD-IS barrier applications.

The blower housing is fitted with primary and secondary fans mounted in a compact in-line arrangement with the secondary fan mounted directly behind the primary fan. Each motor is connected with approved MI (mineral insulated) cable to separate disconnect switches mounted external to the blower housing. The explosion proof control enclosure contains a variable speed drive, a VFD interface card and an array of control switches and indicators. The explosion proof control enclosure can be mounted on any flat wall surface inside or outside of the protected building. A 4" building pressure indicator, scaled to inches of water and color coded to indicate low, high and safe building pressures, is mounted above the explosion proof control enclosure on a stainless steel plate. The building pressure indicator features a 1/4" tube fitting and sintered vent for references of building and atmospheric pressures.

Operation Control Features

FIELD-ADJUSTABLE PRESSURE & ALARM SETPOINTS

PFS - (Primary Fan Speed) Adjusts primary fan speed to set desired pressure. CW (Clockwise) to decrease.

Factory setpoint: 0.25"
Normal range of adjustment: 0.10" to 0.40"

ASP - (Alarm Setpoint) Adjusts alarm setpoint to activate alarm at desired pressure. CW (Clockwise) to decrease.

Factory setpoint: 0.15"
Normal range of adjustment: 0.05" to 0.25"

FIELD-ADJUSTABLE SECONDARY FAN & ALARM DELAYS

SFD - (Secondary Fan Delay) adjusts time delay cycle to prohibit secondary fan from engaging when pressure falls below alarm setpoint.

Factory setpoint: 0 seconds
Normal range of adjustment: 0-35 seconds

ASD - (Alarm Signal Delay) adjusts time delay cycle to prohibit alarm relay from deenergizing when pressure falls below alarm setpoint.

Factory setpoint: 15 seconds
Normal range of adjustment: 0-35 seconds

Notes: Time delay cycles reset automatically if "safe" building pressure is restored before cycles end. All controls permit real-time adjustment.

Emergency Remote Control

OPTIONAL USER INPUTS

ESD - (Emergency Shutdown) When VFD Interface Board jumper is installed, unit allows user to remotely disengage primary and secondary fans, regardless of primary and secondary fan control switch positions.

Typical input devices: emergency shutdown switches, fire extinguishing or alarm systems and stack mounted combustible gas or hydrogen sulfide sensors.

ECO - (Emergency Control Override) When VFD Interface Board jumper is installed, unit allows user to remotely engage primary and secondary fans, regardless of primary and secondary fan control switch positions.

Typical input devices: control room mounted combustible gas, hydrogen sulfide, or oxygen deficiency sensors.

OPTIONAL WIRING METHODS

HW - (Hard Wiring) Selection of this option requires the use of conduit, seals and wiring approved for the location.

IS - (Intrinsically Safe) Selection of this option allows use of intrinsically safe cabling approved for the location.

NOTE: Loops are self-powered 5 VDC 20 ma signals, regardless of wiring method selection. Signals must be maintained independently by normally closed switches to prevent shutdown or override.

PRIORITY SELECTION SWITCH

In cases where both optional inputs are utilized, VFD Interface Board jumper allows user to select the preferred action (shutdown or override) in the unlikely event of simultaneous loss of signal. When VFD Interface Board priority (PTY) jumper is installed, priority is given to the Emergency Control Override function.

See rear cover for ESD & ECO input ordering information.

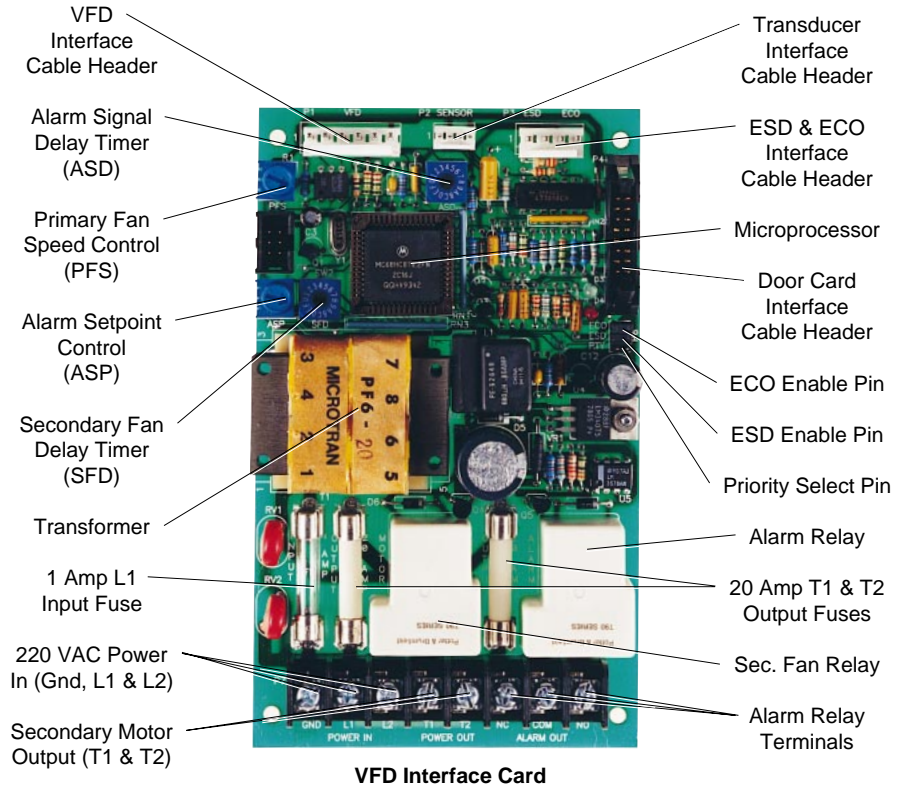
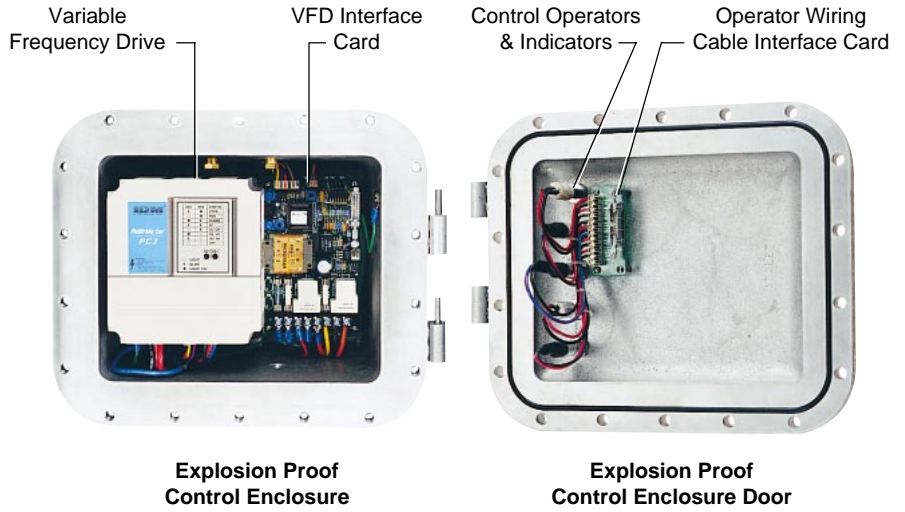

Electrical Field Wiring Diagrams

Optional ESD & ECO Inputs

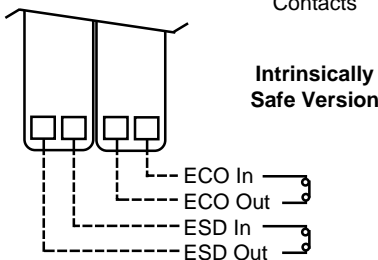
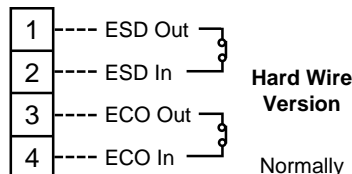

AC Power & Primary Fan VFD Controller Terminal - TM2

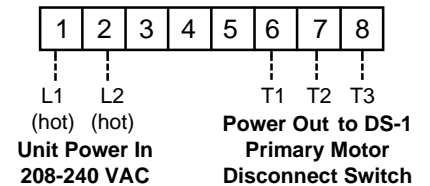

Alarm Relay & Secondary Fan VFD Interface Card Terminal - P4

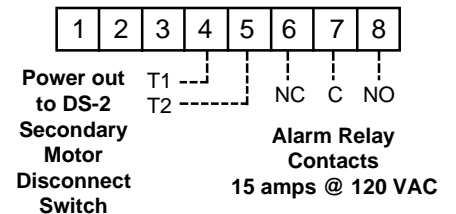

Model RDP-16 Unit Accessories

GALVANIZED OR STAINLESS STEEL SPIRAL PIPE

SP-16-120	10' Flanged Stack Section
SC-16	Flanged & Screened Rain Cap
ST-16	Flanged Tee w/ Coupler
SN-16	Flanged Elbow w/ Coupler
BC-16	Blind Flange Cover Plate
GK-16	Flange Gasket & Bolt Kit

SPIRAL PIPE STACK & GUY WIRE ANCHOR KITS

SPAK-16	Spiral Pipe Anchor Bolt Kit
EAGK-40-1216	Earth Anchor Guy Wire Kit
CAGK-40-1216	Concrete Anch. Guy Wire Kit

GAL. OR S.S. FREE STANDING RIGID PIPE STACKS

RP-16-25	25' 10 Ga Rigid Pipe Stack
RPAK-16	Rigid Pipe Anchor Bolt Kit

ADDITIONAL ITEMS

FDK-16-300	25' Flexible Duct Intake Kit
------------	------------------------------

GAS DETECTOR SYSTEMS

CGDM-100	Combustible Gas Monitor
CGDS-100	Combustible Gas Sensor
HGDM-100	Hydrogen Sulfide Monitor
HGDS-100	Hydrogen Sulfide Sensor
OGDM-100	Oxygen Deficiency Monitor
OGDS-100	Oxygen Deficiency Sensor
GDPS-100	24 VDC Monitor Power Supply
GDSB-1216	Sensor Stack Mount Bracket

REMOTE MOUNT DISCHARGE COMPONENTS

ADGA-16	Adj. Discharge Grill Assembly
DE-16	Discharge Extension
DN-16	Discharge Ninety
DCF-16	Discharge Curb Flange

EMERGENCY REMOTE CONTROL INPUTS

ESD-IS-RM	Intrinsic Safe ESD
ECO-IS-RM	Intrinsic Safe ECO
ESD/ECO-IS-RM	Intrinsic Safe ESD/ECO
ESD/ECO-HW-RM	Hard Wire ESD/ECO

REMOTE ALARM BEACONS AND HORNS

RAB-1	Division 1 Remote Alarm Beacon
RAB-2	Division 2 Remote Alarm Beacon
RAH	Division 1 Remote Alarm Horn

WARNING NAMEPLATES

BPCN-1	Building Pressurization Caution
SDWN-1	Sealed Door Warning

INSTALLATION & OPERATION MANUAL

RDP-16-IOM	Installation & Operation Manual
------------	---------------------------------

Housing Dimensions

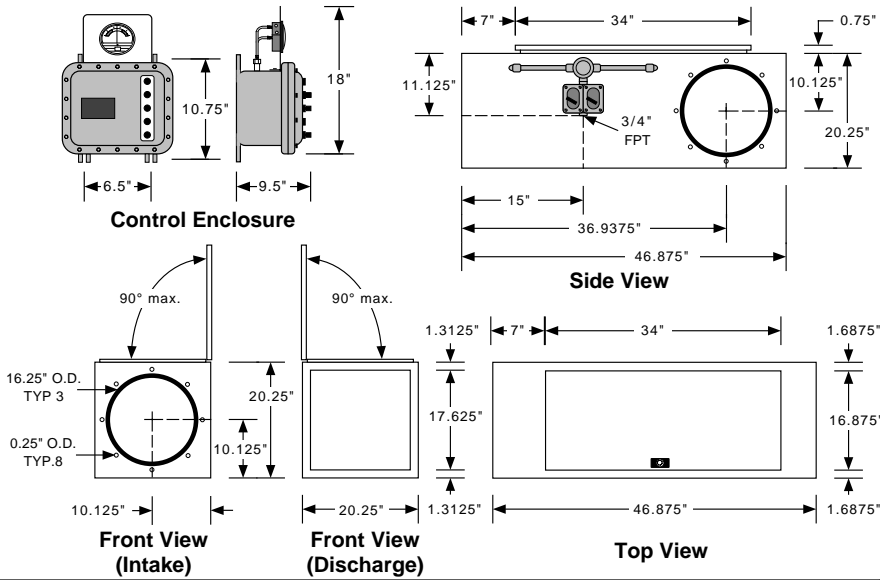

Model Number Designations

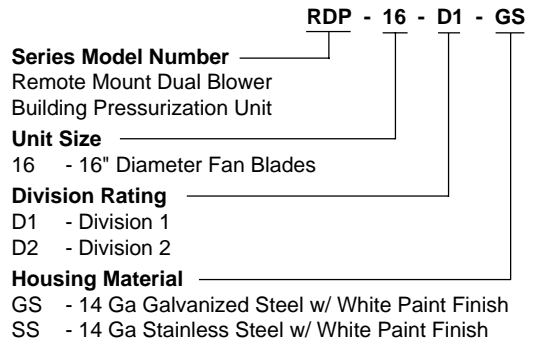

FOUR (4) VIBRATION DAMPENING MOUNTS WITH SCREWS, ONE (1) BPCN-1 NAMEPLATE & ONE (1) INSTALLATION & OPERATION MANUAL PROVIDED WITH EACH UNIT

Typical Installations

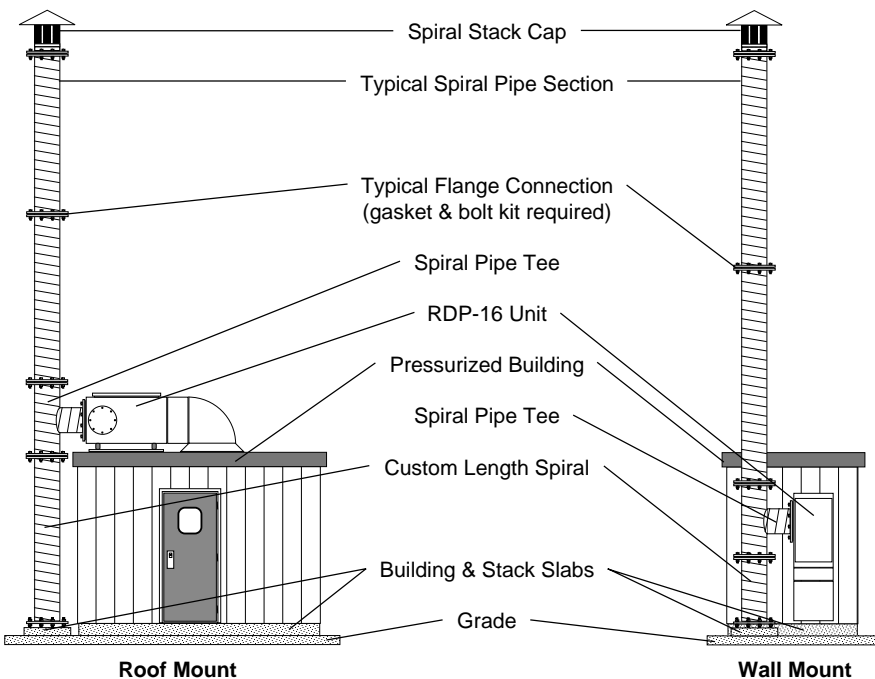

Local Sales Representative

IMPORTANT NOTES

All specifications subject to change without notice. Warranty & Liability policies available upon request.

The simplified installation diagrams to the left are shown without guy wire or structural support systems, for the purpose of maintaining diagram clarity.

Installer must recognize the need for adequate stack guy wire or structural support systems as well as foundation anchoring systems. Installer assumes all liability for the installation and integrity of said systems, wherein design considerations should ensure that stack guy wire or structural support systems are capable of withstanding local inclement weather conditions.