

**Opening: 31 Sq Ft Maximum
Area: 250 Sq Ft Maximum**

Technical Description

Model WDP-16 is a pressurization unit for control rooms or buildings containing no internal source of flammable vapors or gases. The unit utilizes a primary and secondary fan to pressurize rooms or buildings with opening(s) not exceeding a total of 31 square feet and a floor area not exceeding 250 square feet. The primary fan is controlled by a variable speed drive to maintain a safe (0.25") pressure when the doorway is sealed. The secondary fan engages upon loss of safe pressure, to generate a minimum air velocity of sixty (60) feet per minute through the doorway, and functions as a redundant fan if the primary fan fails. This unit, combined with an intake stack that draws fresh air from a nonhazardous area, reduces the hazardous (classified) area rating within the room or building from Class I, Division 1 or 2 to nonhazardous, in accordance with NFPA 496, Chapter 5.

Basic Operation

Unit must be powered by a local disconnect switch connected ahead of building power or connected to a separate power source. The unit is started by closing the building door and placing the secondary fan switch in the "automatic" position and the primary fan switch in the "on" position. The primary fan then engages to regulate air flow and maintain a safe pressure. When the door is opened, pressure will fall below the alarm setpoint. The primary fan will then increase velocity, and the unit will activate an alarm signal delay timer and a secondary fan delay timer. Both timers are field-adjustable, to permit immediate or delayed response to changes in pressure. Both timers are activated and reset as pressure falls below and rises above the alarm setpoint. If the secondary fan or alarm engages, they disengage when the door is sealed and pressure rises above the alarm setpoint.

DIVISION 1 AREA APPLICATION NOTE:

INSTALLER MUST PROVIDE DISCONNECT EQUIPMENT TO AUTOMATICALLY REMOVE POWER FROM ALL NONRATED DEVICES, UPON FAILURE OF THE PRESSURIZATION UNIT.

Standard Controls

Primary Fan "On" Indicator

- indicates that primary fan is engaged

Primary Fan Control Switch

- engages and disengages primary fan

Secondary Fan Control Switch

- off, manual and automatic positions

Alarm "Engaged" Indicator

- indicates alarm signal is active

- flashes when alarm signal is bypassed

Alarm Signal Bypass Switch

- latches and unlatches alarm relay

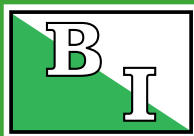

MODEL WDP-16

WALL MOUNT DUAL BLOWER BUILDING PRESSURIZATION UNIT

ECU Division Technical Bulletin WDP-16-R1.0

05/97



**Front View
(with mounting bezel attached)**

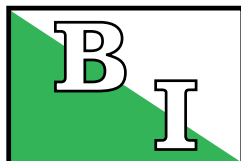

Bebco Industries
Environmental Control Units Division

600 Gulf Freeway
Texas City, TX 77591
PHN: (409) 935-5743
FAX: (409) 938-4189

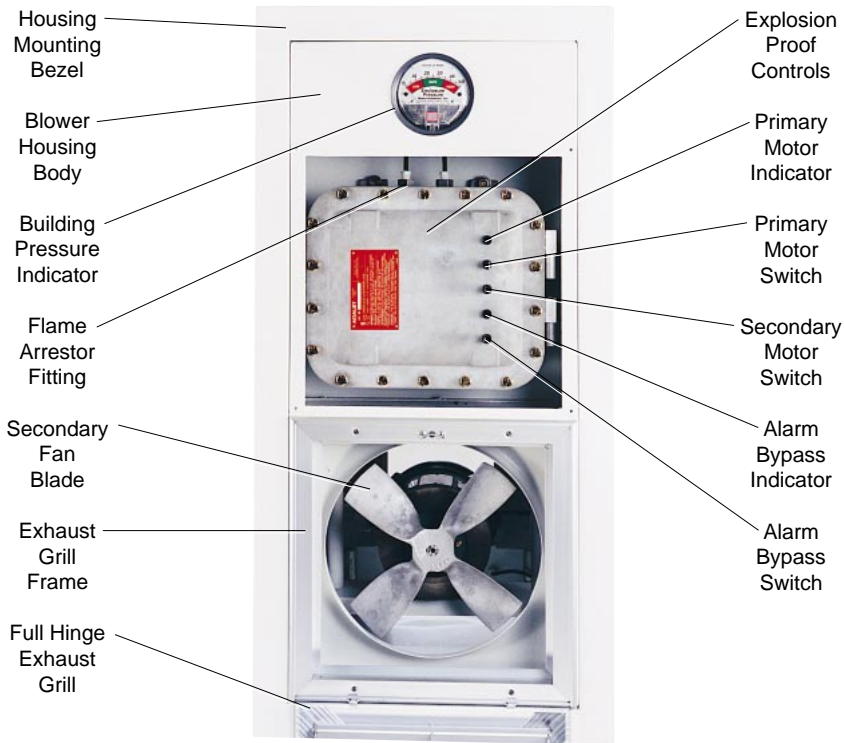

Front View
with exhaust grill open and control enclosure cover plate removed

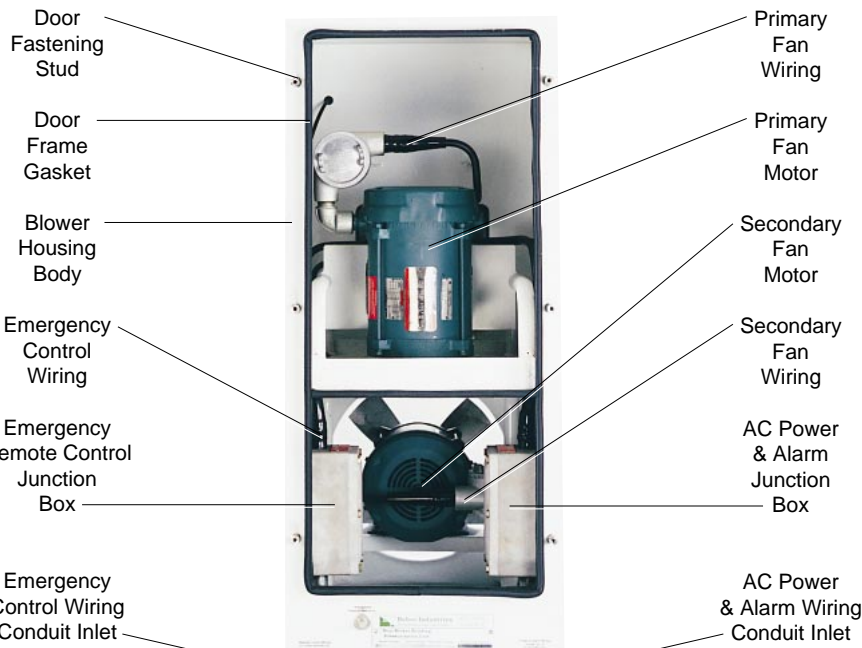

Rear View
with access door removed

Intrinsic Safe Version

Hard Wire Version



Optional Emergency Remote Control Junction Boxes

AC Power & Alarm Junction Box

Unit Specifications

Shipping Dimensions:	54" h x 29" w x 38" d
Shipping Weight (Lbs):	410
Operating Temp Range:	-40° F - 120° F
Power Requirements:	208 / 240 VAC 1Ø, 20 A
Safe Pressure Setpoint:	0.25" - field adjustable
Alarm Setpoint:	0.15" - field adjustable
Average CFM:	* 79.03
Maximum CFM:	2450
Normal Sound Level:	** 60 db min. / 70 db max.
Fresh Air Intake:	16" Diameter
Field Wiring Conduit Entries:	3/4" FPT
Alarm Contact Rating:	15 Amps @ 120 VAC
Division 1 Unit Motors:	Rated Cl. I, Div. 1, Gr. C & D
Division 2 Unit Motors:	Rated Cl. I, Div. 2, Gr. C & D
Primary Motor:	3Ø Inverter Duty, T3, 80 Hz
Secondary Motor:	1Ø Perm. Split Cap., T3, 60 Hz
Primary Motor RPM:	2000 Max.
Secondary Motor RPM:	1725 Max.

* Average CFM through a 31 square feet opening

** Normal sound level tested in acoustic sound chamber with primary fan engaged and door sealed

Material Specifications

NEMA 4 Blower Housing:	* Painted 14 Ga Galv. Steel
NEMA 4X Blower Housing:	*Painted 14 Ga 316 SS
Fan Venturis:	Painted Carbon Steel
Fan Blades:	Nonsparking Alum.
Pressure Gauge:	Alum. w / Enamel Finish
Tube Fittings:	316 SS & Nylon
Press. Reference Tubing:	1/4" Heavy Wall Tygon
Unit & Device Nameplates:	Silkscreened Lexan®
Model Number Nameplate:	Silkscreened SS
Fastener Hardware:	SS Screws & Bolts
Rear Door Fasteners:	Cast Zinc Body / Zinc Bolt
Elect. Enclosure & Fittings:	Cast Zinc & Aluminum
Electrical Wiring:	Brass MI Cable & Fittings w/ PVC Jacket

* Paint Finish Specifications:

2 mil epoxy primer & 2 mil white textured urethane finish

Lexan® is a registered trademark of the General Electric Corporation

Mechanical Description

The body of Model WDP-16 is a seal welded NEMA 4 or 4X blower housing that features one (1) full size rear access door, three (3) intake stack openings, two (2) stack opening covers, one (1) removable wall mounting bezel, four (4) mounting angle brackets, one (1) exhaust grill and one (1) reusable aluminum screen filter. The housing is suitable for self-supported mounting through walls up to 8" thick, and it can be inserted from the inside or outside.

The blower housing is fitted with primary and secondary fans, mounted in a compact, vertical arrangement, to reduce consumption of horizontal wall space. The primary fan occupies the top position, to minimize control room noise levels during normal operation. The secondary fan occupies the bottom position, just behind the exhaust grill. The housing features a sealed cavity above the exhaust grill which contains an explosion proof control enclosure. The enclosure contains a variable speed drive, a VFD interface card, and an array of control switches and indicators. The housing is fitted with a screw fastened cover plate that conceals the cavity and explosion proof control enclosure. Above the cover plate, the housing is fitted with a 4" building pressure indicator which is scaled to inches of water and color coded to indicate low, high and safe building pressures. The housing features a power and alarm junction box and an optional emergency remote control junction box for wiring. All devices are connected with approved fittings and MI (mineral insulated) cable.

Operation Control Features

FIELD-ADJUSTABLE PRESSURE & ALARM SETPOINTS

PFS - (Primary Fan Speed) Adjusts primary fan speed to set desired pressure. CW (Clockwise) to decrease.

Factory setpoint: 0.25"
Normal range of adjustment: 0.10" to 0.40"

ASP - (Alarm Setpoint) Adjusts alarm setpoint to activate alarm at desired pressure. CW (Clockwise) to decrease.

Factory setpoint: 0.15"
Normal range of adjustment: 0.05" to 0.25"

FIELD-ADJUSTABLE SECONDARY FAN & ALARM DELAYS

SFD - (Secondary Fan Delay) adjusts time delay cycle to prohibit secondary fan from engaging when pressure falls below alarm setpoint.

Factory setpoint: 0 seconds
Normal range of adjustment: 0-35 seconds

ASD - (Alarm Signal Delay) adjusts time delay cycle to prohibit alarm relay from deenergizing when pressure falls below alarm setpoint.

Factory setpoint: 15 seconds
Normal range of adjustment: 0-35 seconds

Notes: Time delay cycles reset automatically if "safe" building pressure is restored before cycles end. All controls permit real-time adjustment.

Emergency Remote Control

OPTIONAL USER INPUTS

ESD - (Emergency Shutdown) When VFD Interface Board jumper is installed, unit allows user to remotely disengage primary and secondary fans, regardless of primary and secondary fan control switch positions.

Typical input devices: emergency shutdown switches, fire extinguishing or alarm systems and stack mounted combustible gas or hydrogen sulfide sensors.

ECO - (Emergency Control Override) When VFD Interface Board jumper is installed, unit allows user to remotely engage primary and secondary fans, regardless of primary and secondary fan control switch positions.

Typical input devices: control room mounted combustible gas, hydrogen sulfide, or oxygen deficiency sensors.

OPTIONAL WIRING METHODS

HW - (Hard Wiring) Selection of this option requires the use of conduit, seals and wiring approved for the location.

IS - (Intrinsically Safe) Selection of this option allows use of intrinsically safe cabling approved for the location.

NOTE: Loops are self-powered 5 VDC 20 ma signals, regardless of wiring method selection. Signals must be maintained independently by normally closed switches to prevent shutdown or override.

PRIORITY SELECTION SWITCH

In cases where both optional inputs are utilized, VFD Interface Board jumper allows user to select the preferred action (shutdown or override) in the unlikely event of simultaneous loss of signal. When VFD Interface Board priority (PTY) jumper is installed, priority is given to the Emergency Control Override function.

See rear cover for ESD & ECO input ordering information.

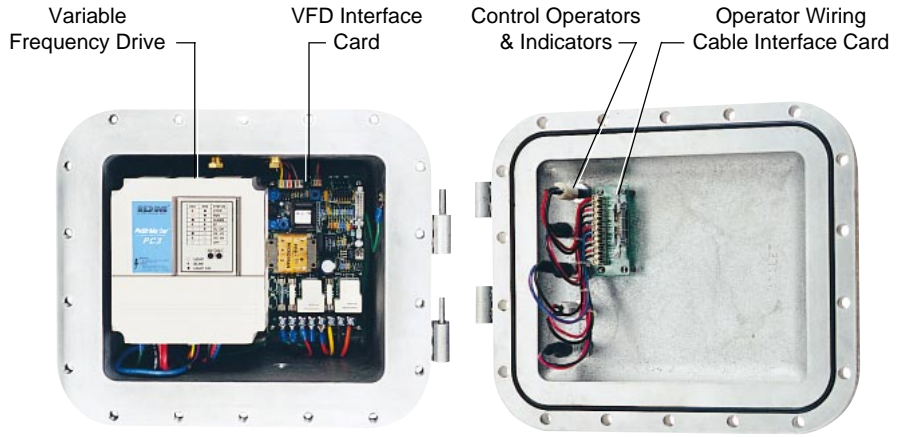

Explosion Proof Control Enclosure

Explosion Proof Control Enclosure Door

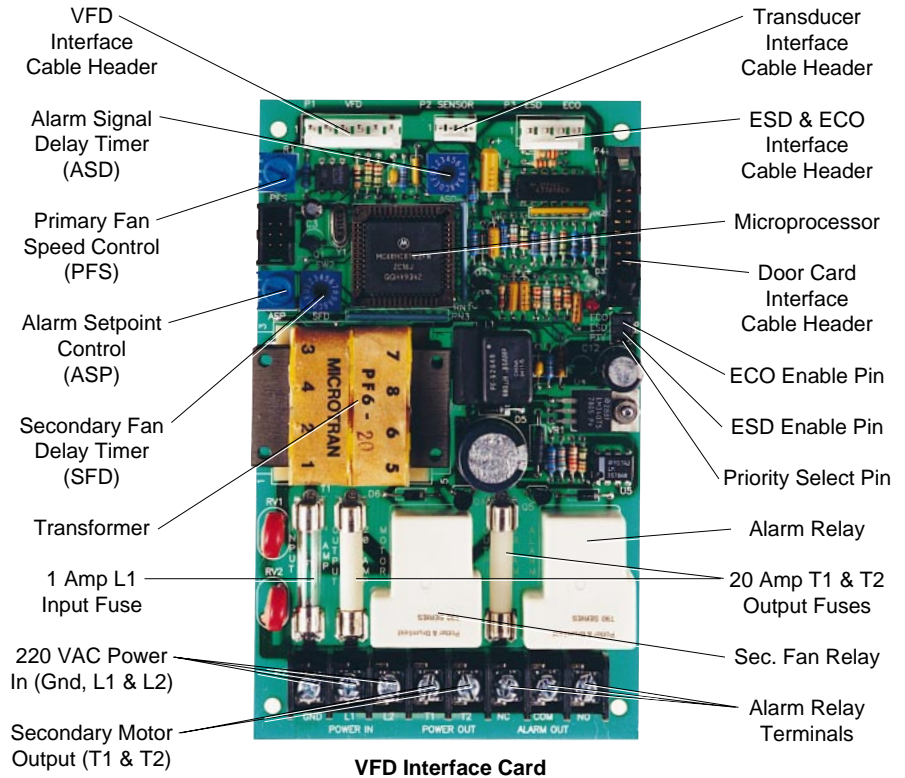

VFD Interface Card

Junction Box Electrical Wiring Diagram

Optional ESD & ECO Input Junction Box

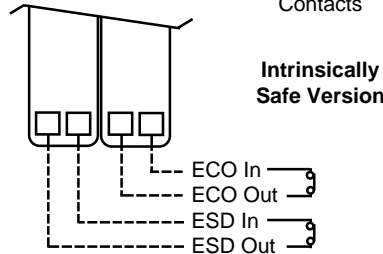
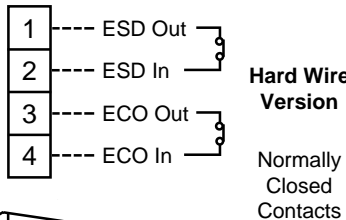

AC Power & Alarm Junction Box

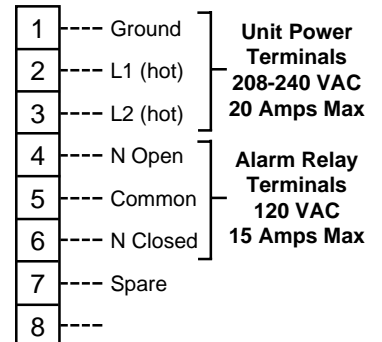

Model WDP-16 Unit Accessories

GALVANIZED OR STAINLESS STEEL SPIRAL PIPE

SP-16-120 10' Flanged Stack Section
 SC-16 Flanged & Screened Rain Cap
 ST-16 Flanged Tee w/ Coupler
 SN-16 Flanged Elbow w/ Coupler
 BC-16 Blind Flange Cover Plate
 GK-16 Flange Gasket & Bolt Kit

SPIRAL PIPE STACK & GUY WIRE ANCHOR KITS

SPAK-16 Spiral Pipe Anchor Bolt Kit
 EAGK-40-1216 Earth Anchor Guy Wire Kit
 CAGK-40-1216 Concrete Anchor Guy Wire Kit

GAL. OR S.S. FREE STANDING RIGID PIPE STACKS

RP-16-25 25' 10 ga Rigid Pipe Stack
 RPAK-16 Rigid Pipe Anchor Bolt Kit

ADDITIONAL ITEMS

FDK-16-300 25' Flexible Duct Intake Kit
 AUSK-5 Adjustable Unit Support Kit
 EDS-240-20-2 2 Pole 20 Amp Disconnect

INSTALLATION & OPERATION MANUAL

WDP-16-IOM Inst. & Operation Manual

GAS DETECTOR SYSTEMS

CGDM-100 Combustible Gas Monitor
 CGDS-100 Combustible Gas Sensor
 HGDM-100 Hydrogen Sulfide Monitor
 HGDS-100 Hydrogen Sulfide Sensor
 OGDM-100 Oxygen Deficiency Monitor
 OGDS-100 Oxygen Deficiency Sensor
 GDPS-100 24 VDC Monitor Power Supply
 GDSB-1216 Sensor Stack Mount Bracket

WARNING NAMEPLATES

BPCN-1 Building Pressurization Caution
 SDWN-1 Sealed Door Warning

EMERGENCY REMOTE CONTROL INPUTS

ESD/ECO-HW-16 Hard Wire ESD & ECO
 ESD/ECO-IS-16 Intrin. Safe ESD & ECO
 ESD-IS-16 Intrin. Safe ESD
 ECO-IS-16 Intrin. Safe ECO

REMOTE ALARM BEACONS AND HORNS

RAB-1 Div. 1 Remote Alarm Beacon
 RAB-2 Div. 2 Remote Alarm Beacon
 RAH Div. 1 Remote Alarm Horn

Model Number Designations

WDP - 16 - D1 - GS

Series Model Number ————
 Wall Mount Dual Blower
 Building Pressurization Unit

Unit Size ————
 16 - 16" Diameter Fan Blades

Division Rating ————
 D1 - Division 1
 D2 - Division 2

Housing Material ————
 GS - 14 Ga Galvanized Steel w/ White Paint Finish
 SS - 14 Ga Stainless Steel w/ White Paint Finish

ONE (1) BPCN-1 NAMEPLATE & ONE (1) INSTALLATION & OPERATION MANUAL PROVIDED WITH UNIT

Housing Dimensions

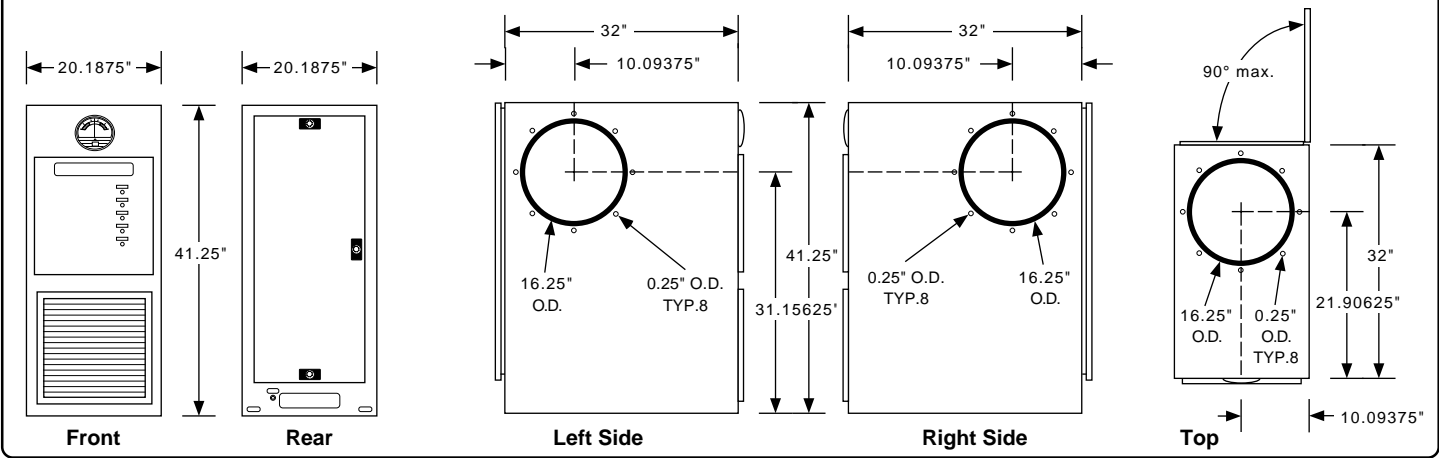

Typical Installation

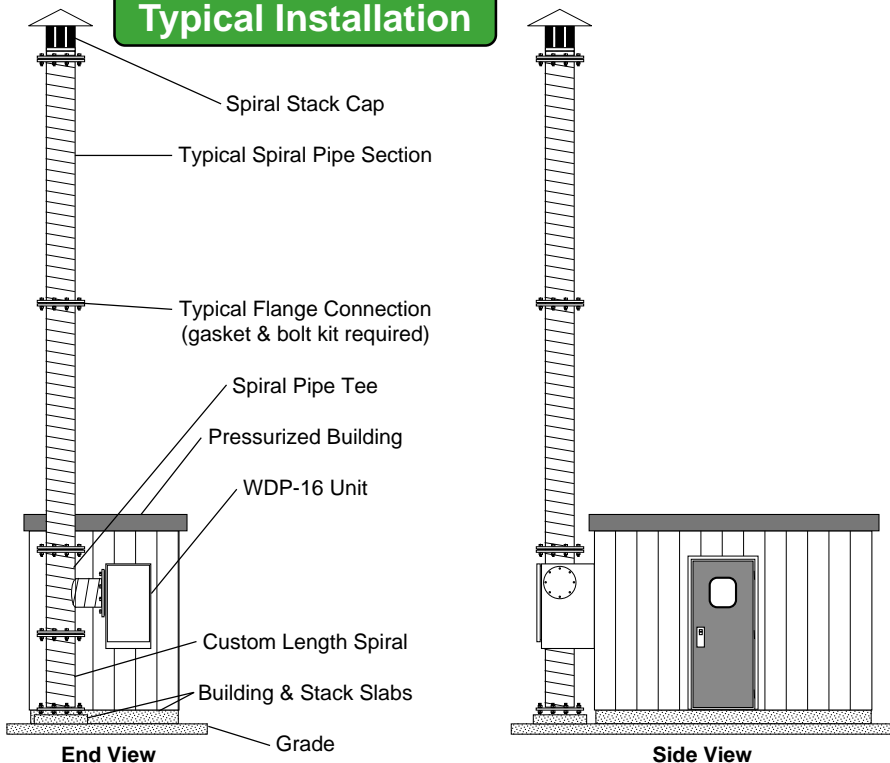

Local Sales Representative

Area for local sales representative information.

IMPORTANT NOTES

All specifications subject to change without notice. Warranty & Liability policies available upon request.

The simplified installation diagrams to the left are shown without guy wire or structural support systems, for the purpose of maintaining diagram clarity.

Installers must recognize the need for adequate stack guy wire or structural support systems as well as foundation anchoring systems. Installers assume all liability for the installation and integrity of said systems, wherein design considerations should ensure that stack guy wire or structural support systems are capable of withstanding local inclement weather conditions.